



Bhatar construction

Timber reinforced masonry

An illustrated guide for craftsmen

Bhatar is a traditional construction system consisting of stone masonry with horizontal timber reinforcement bands. These bands (with cross pieces) act as seismic bands which prevent the walls from falling apart in an earthquake. Proper connection of the timber elements is critical for safety.



Contemporary Bhatar construction
Tarand - NWFP - Pakistan



Traditional Bhatar construction
Besham Fort (c. 1750) NWFP - Pakistan

1. Site Selection and Form of House

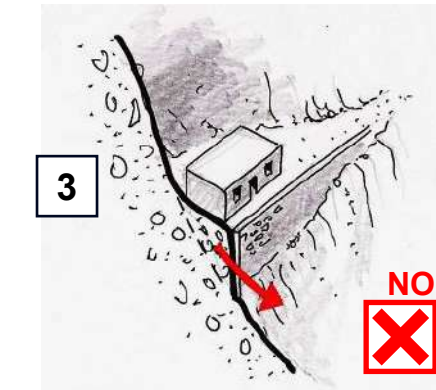
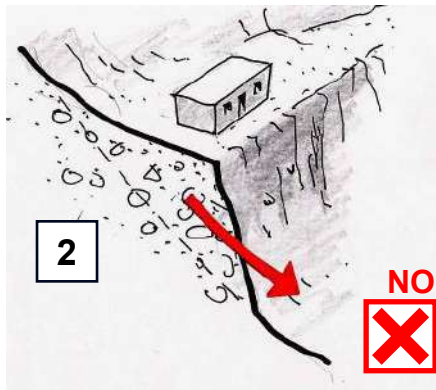
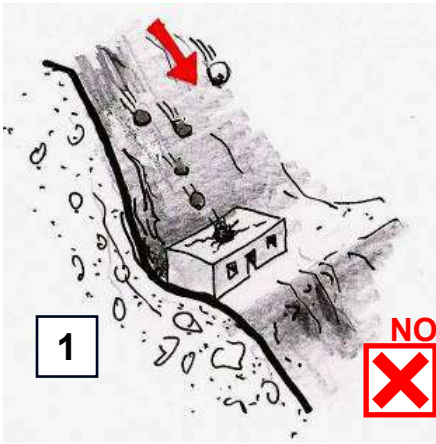

1. Don't build too near to a steep slope: stones might fall on your house.
2. Don't build too near to a precipice: it might break off during an earthquake.
3. Don't build too near to a retaining wall: it might break away during an earthquake.
4. The house must have a simple form. If necessary, subdivide it into rectangular parts.
5. The house must not be longer than 3 times its width W .
6. A light pitched roof is much better than a flat heavy roof.

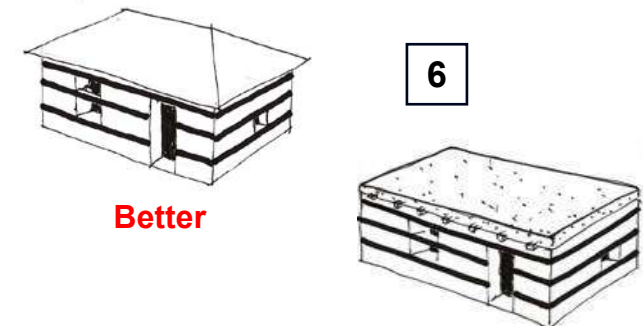
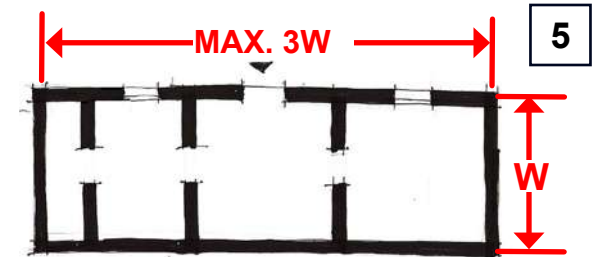
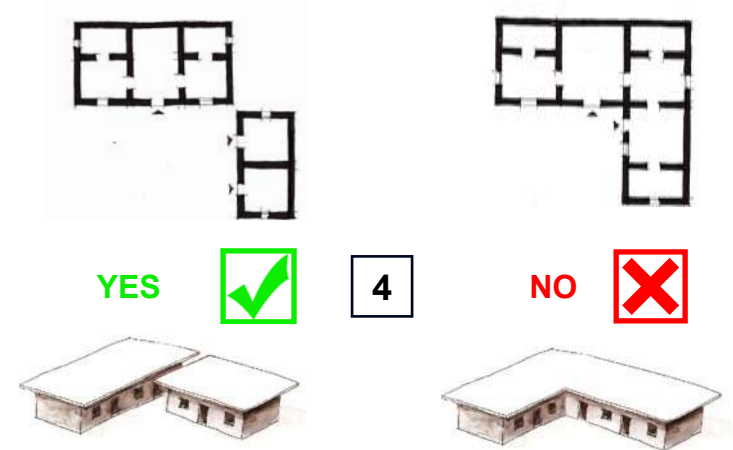

2. Basic Rules

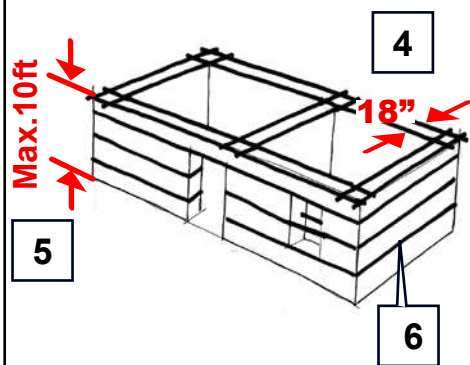
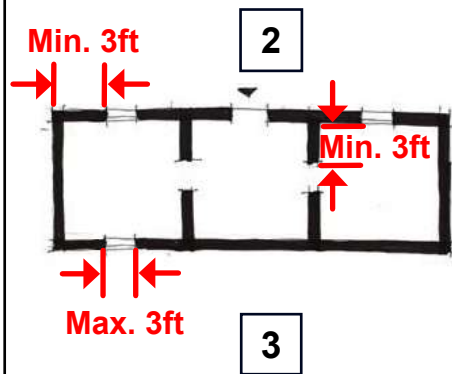
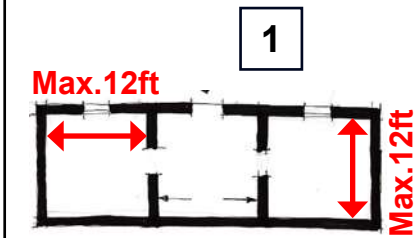

1. No wall must be longer than 12 feet without being connected to another wall.

2. Openings should be minimum 3 feet from corners or other opening.

3. Windows must be smaller than 3 feet.

4. Walls must be 18 inches thick. Do not make walls thicker than 18 inch.

5. Walls must not be higher than 10 feet.

6. The timber beams act as 'seismic bands'. The bands should be continuous and well connected.

7. Use Blue Pine (pavich/biar) or Cedar (deodar) for the beams.

8. Use galvanized nails (with zinc layer) for all work except inside the house (so they do not rust).

9. Use flat or dressed stones for your masonry. Don't use round rubbles.

10. All walls must be connected to each other with proper stone masonry and timber beams.

11. Place through-stones every two feet. They make the wall stronger.

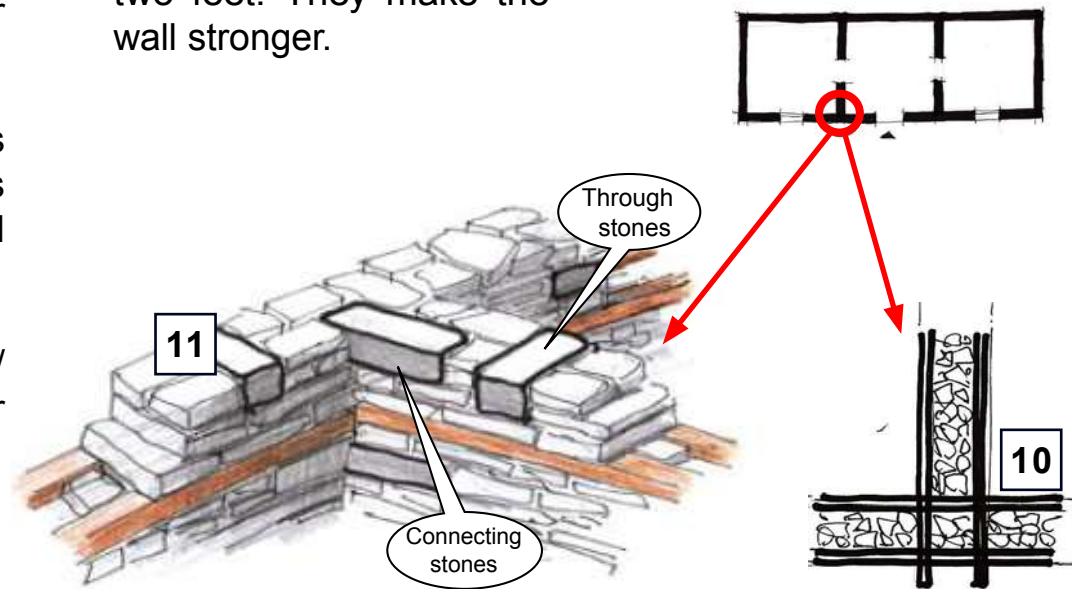
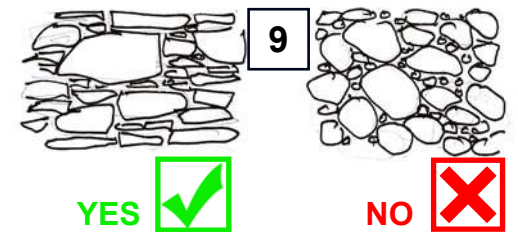
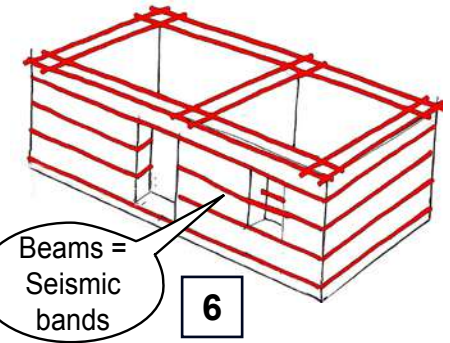

3. Foundations and Plinth Band

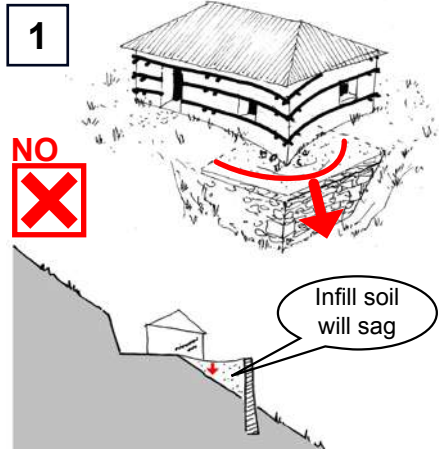

1. Build your house on soil that is all of the same quality. Don't place one part of the house on infill soil.

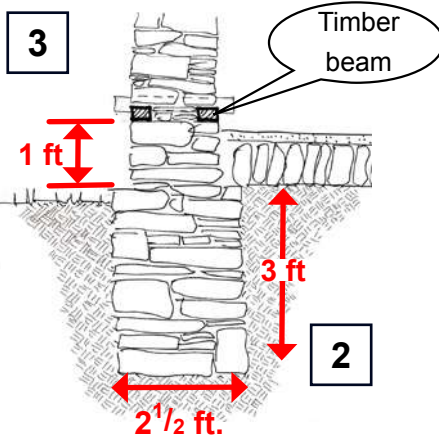

2. Foundations should be at least 2½ feet wide and 3 feet deep.

3. The plinth band should be placed 1 foot above the foundation (1 foot out of the ground).

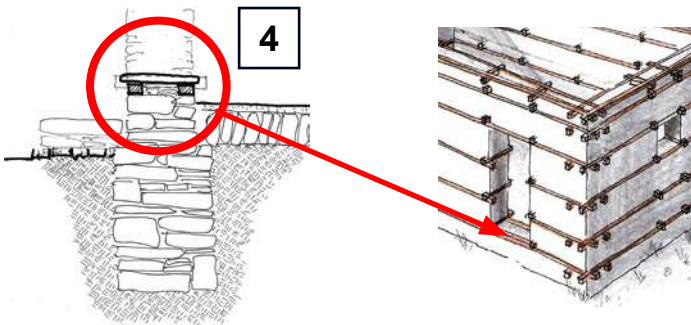

4. The plinth band will pass under the door.

5. It is better to make the first seismic band in reinforced concrete instead of wood. It will not rot.

6. Make sure that all rebars are covered all around with 1 ½" of concrete to avoid rusting of rebars.

7. Take care to cross the corner rebars correctly. For plinth reinforcement use two # 4 bars with # 2 bars (stirrups) every 6".

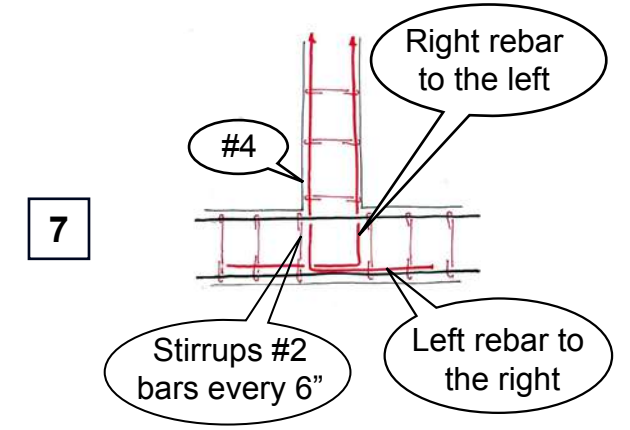
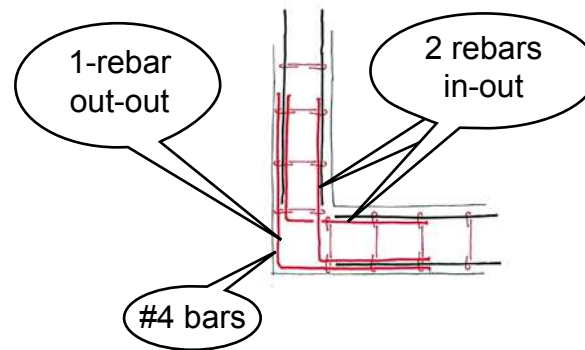
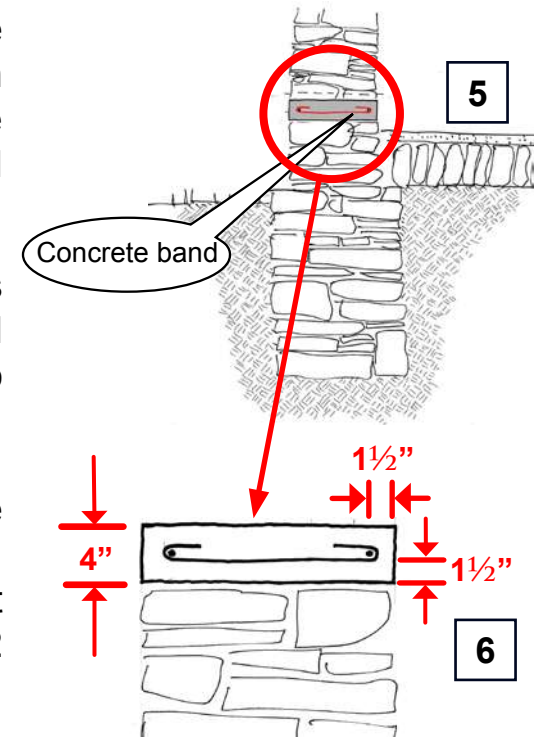

4. Walls

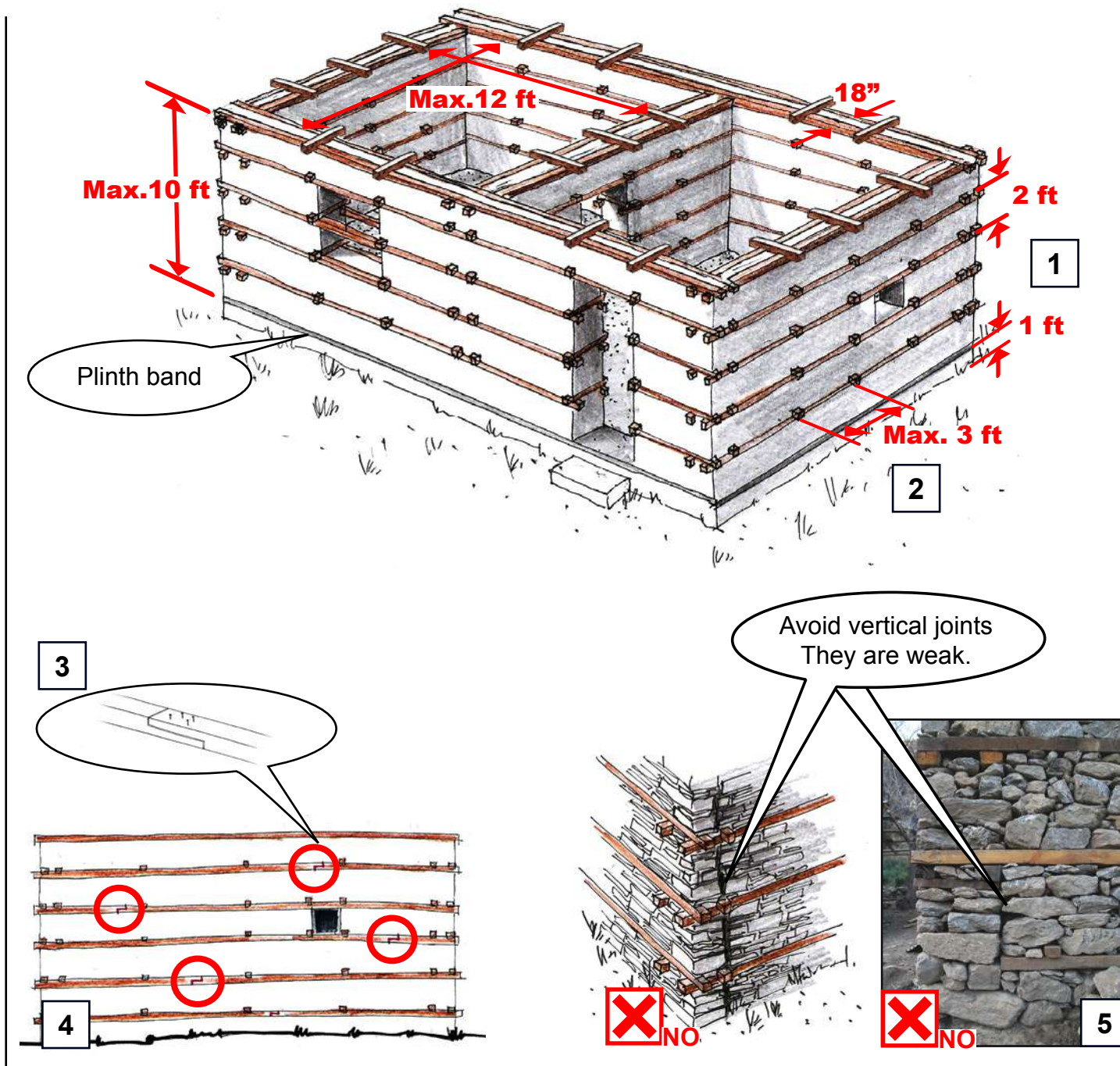

1. Place the wall beams every 2 feet, above the plinth band.
2. Place cross pieces at a maximum distance of 3 feet from each other.
3. If timber beams are too short, connect them with a long lap joint (see next page).
4. Don't connect the beams all on the same vertical line, but spread the connection points.
5. Raise all walls together to avoid vertical joints which create weak corners.

5. Connections

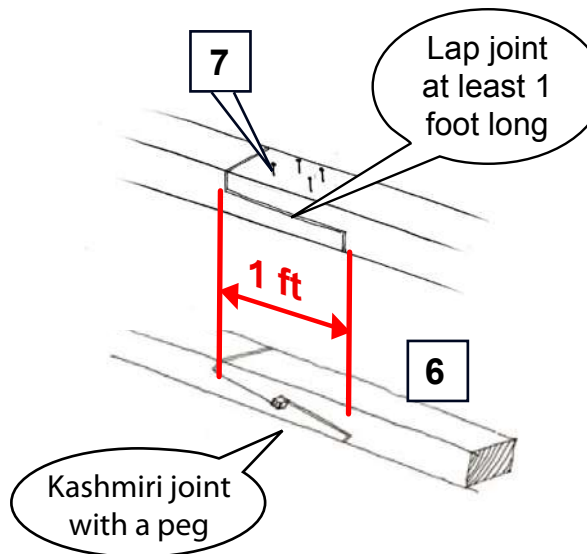
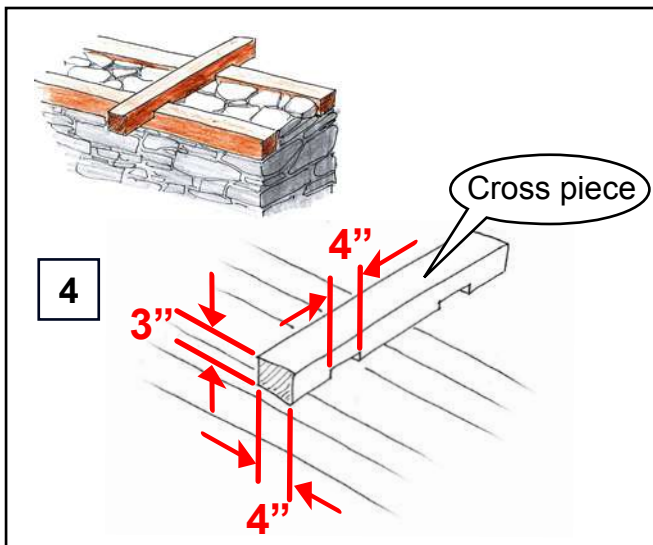
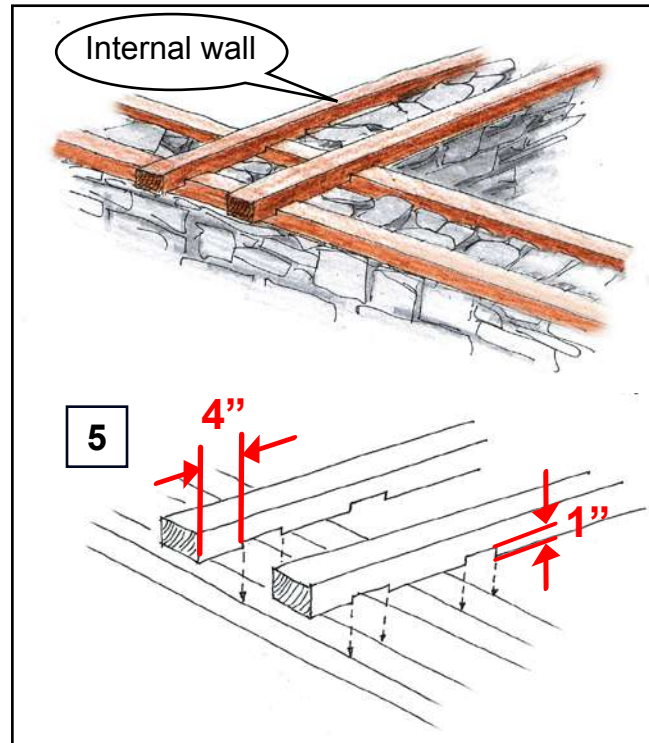
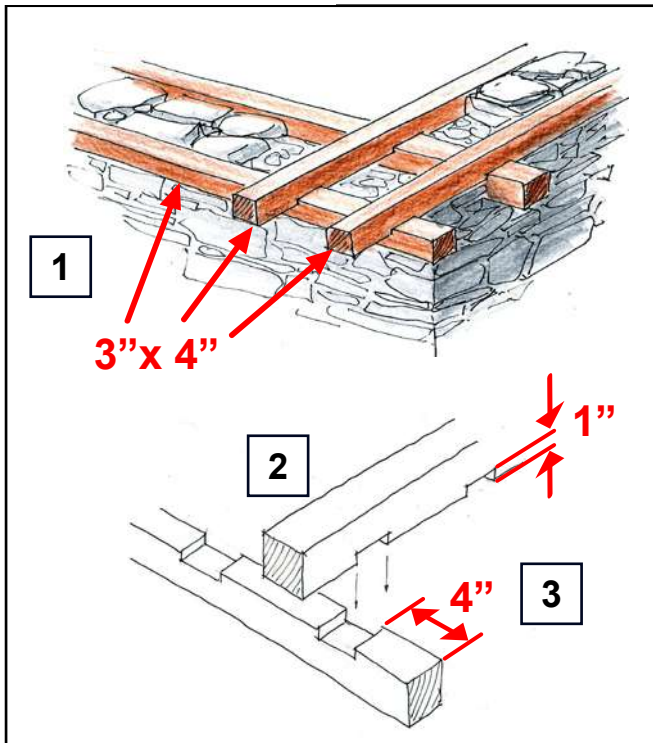

1. Minimum size of beam is 3" high by 4" wide.
2. Beams must be hooked together in the corners. Cut a notch of 1" into all four corner beams. Add 2 nails (3") for more security.
3. Keep 4" of wood after all notches for strength.
4. Cross pieces help to hold the beams and walls together. You need notches only on the cross pieces, but not on the main beams.
5. Where internal walls connect, only notch the internal wall beams, not the main beams.
6. Joints must be 1 foot long. For lap joints use four 3" nails to secure each joint. For Kashmiri joints, use a peg.
7. If you use a lap joint, the nails must be galvanized. They will not rust.

6. Windows and Doors

1. Distance between openings should be minimum 3 feet.
2. Windows and doors must not be wider than 3 feet.
3. Place the windows between the beams.
4. If you need a taller window, let the beams pass through.
5. Place cross pieces on both sides of windows and doors.
6. Don't trim the ends of the beams to place your door.
7. For lintel add two pieces of wood in between the existing beams to support stones above. It must pass at least 1 foot into masonry on each side of the opening.

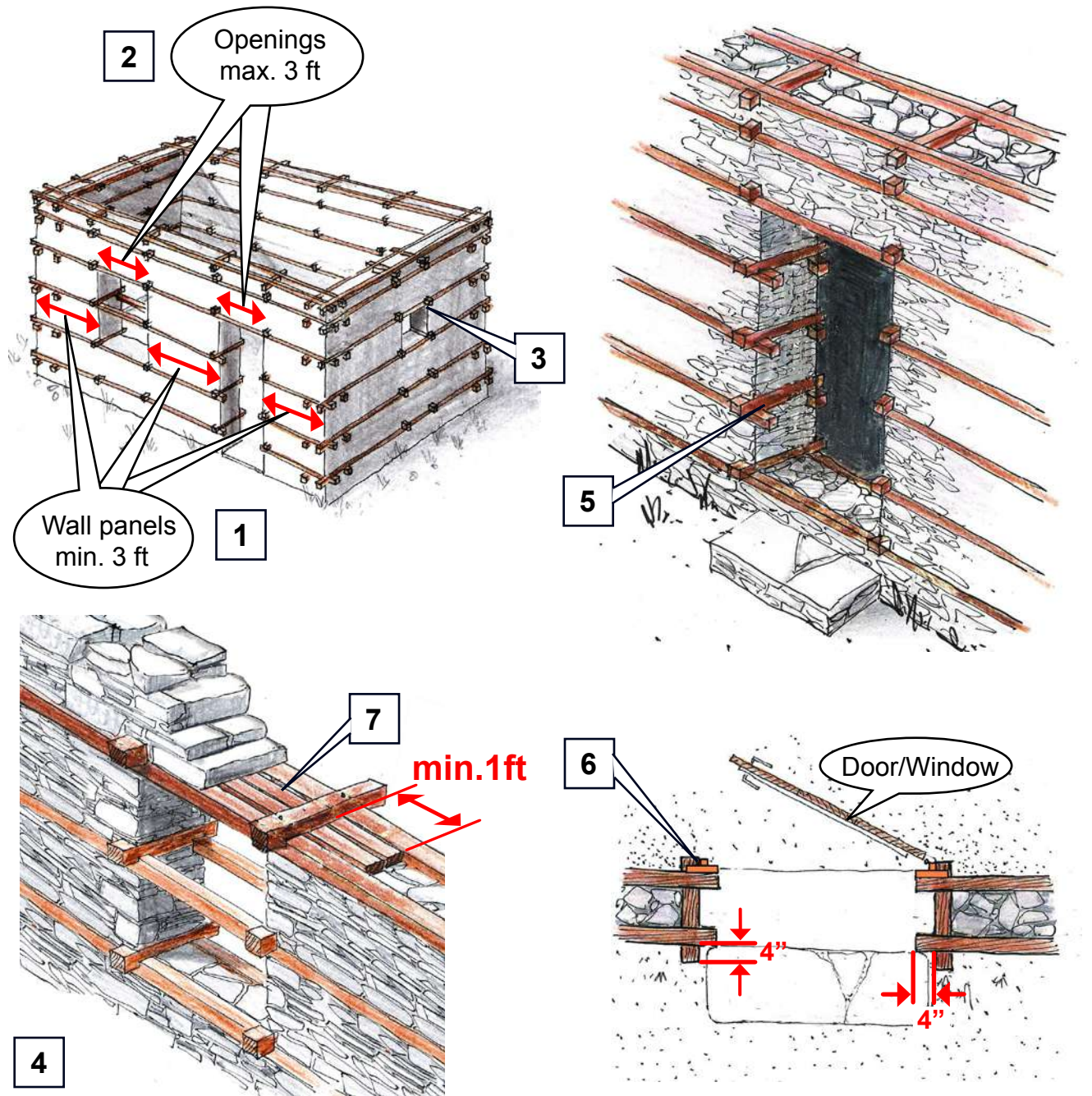

7. Pitched roof with CGI sheets

1. Take care to link the last and second last pair of beams with nailed boards. This makes the top of the wall stronger.
2. Let the rafters extend beyond the wall at least 2 feet to protect walls against rain.
3. To ensure good anchoring of the roof to the walls, connect the trusses to the last pair of beams with wooden pieces or metallic straps.

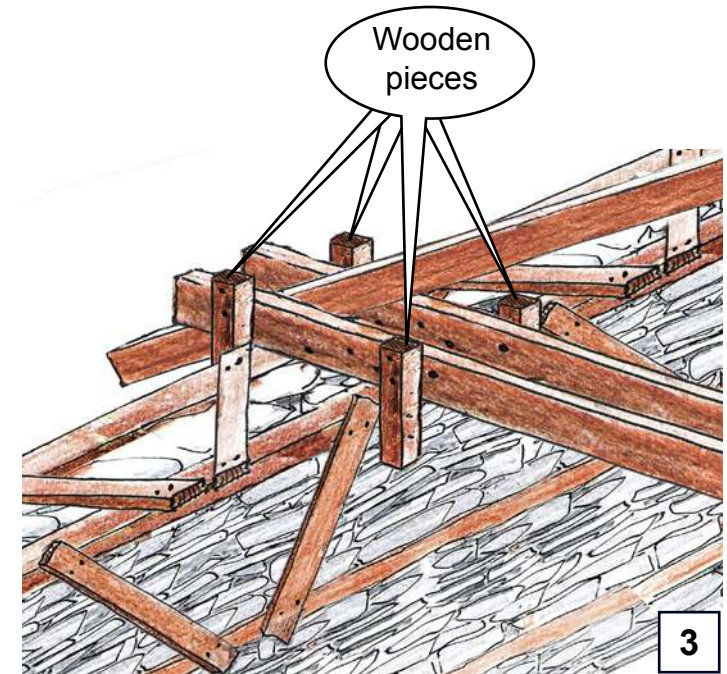
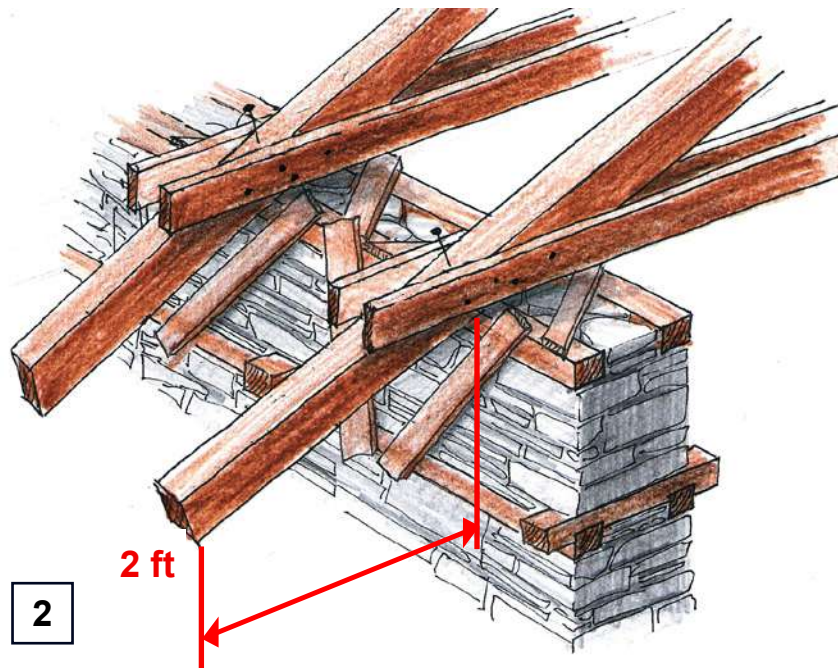
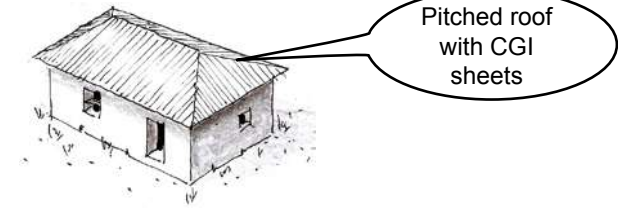
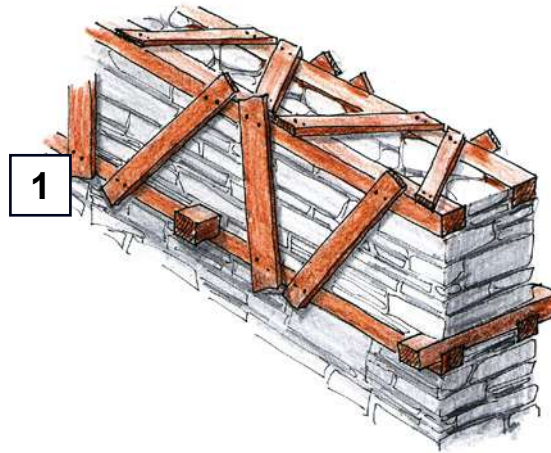

8. Flat roof with earth cover

1. Let the top beams (bhateri) extend beyond the wall 1 foot on each side. Connect them with nailed cross pieces.
2. Add the 4"x6" roof beams and extend them 1 foot beyond each wall. Do not use large beams: they are heavy and dangerous.
3. Nail the planks on the roof beams leaving a half inch gap between each.
4. Add twigs and small branches in a layer 4 to 6 inches thick.
5. Cover with earth 4 to 6 inches thick.
6. Avoid making the earth cover thicker over the years. Don't exceed 6 inches thick; it would make the roof too heavy and unsafe.

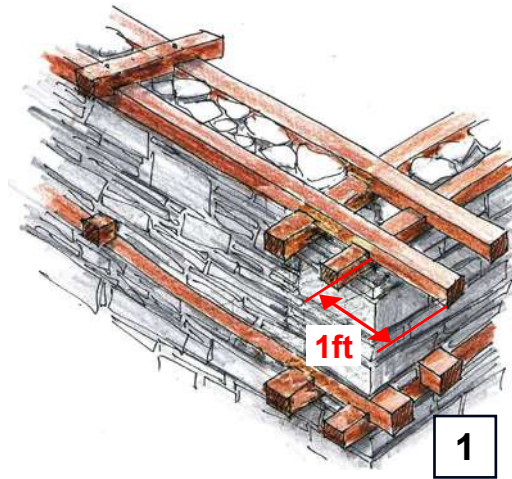

Ask an experienced builder to help you build the roof cover.

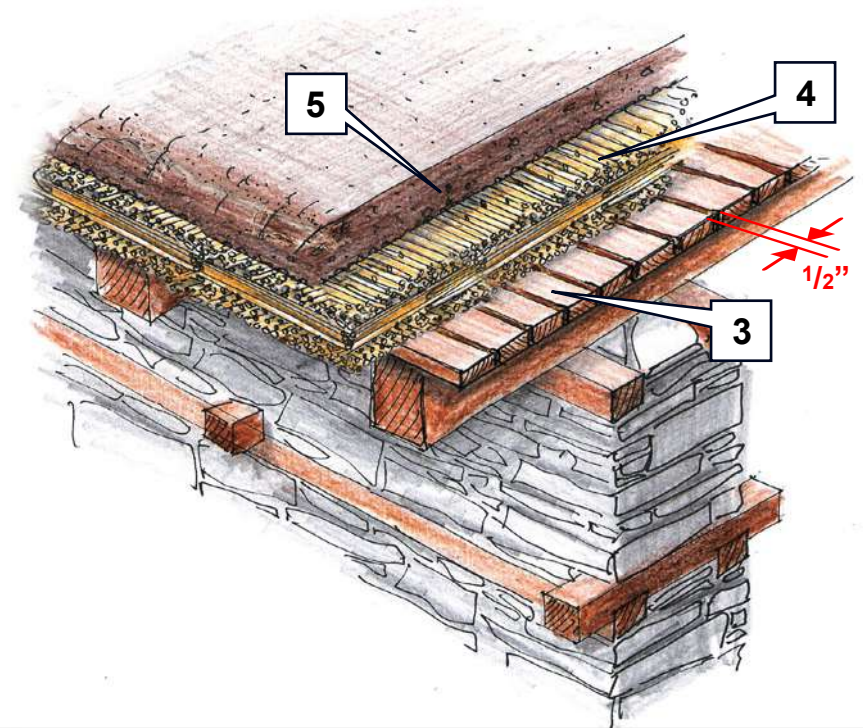
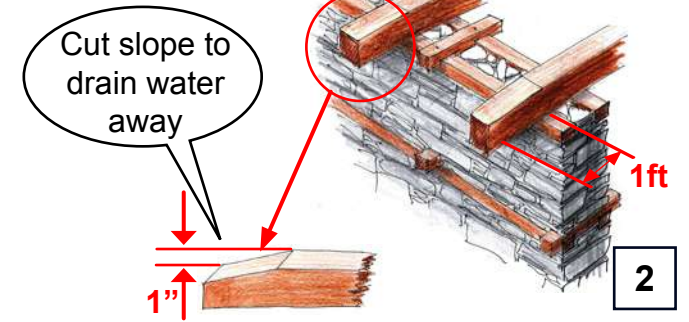
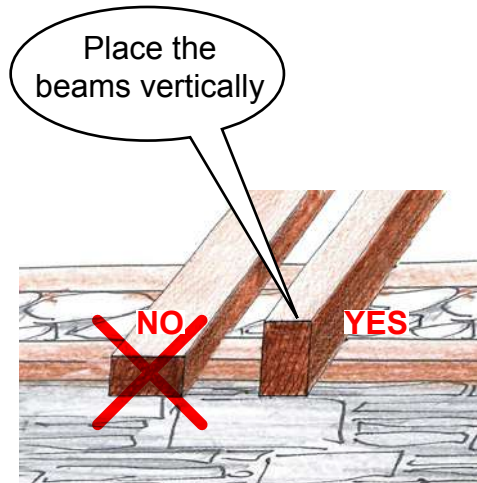

9. Flat roof structure dimensions

Small rooms (max 10ft.):

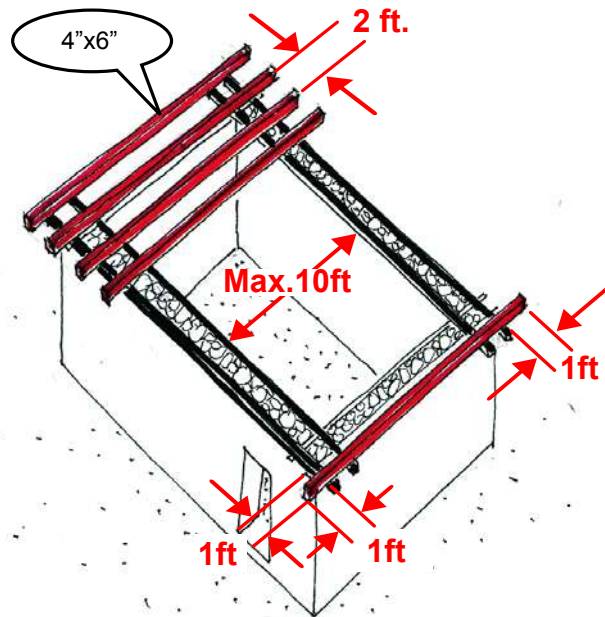

1. Place 4"x6" roof beams every 2 feet.
2. Extend the roof beam beyond the walls 1 foot on each side.

Big rooms (max 12ft.):

1. If you want to cover a big room, you don't need an independent timber structure.
2. Place a beam 5"x7" through the middle of the room and support it in the centre with a post.
3. Don't plant the post in the ground, but put it on a flat stone.
4. If the central beam is not long enough, join it on top of the post with a long lap joint.
5. Add a capital underneath and fix it to the beam with pegs and straps.
6. Add 4"x 4" top beams if you place them 1½ feet apart, or 4"x 5" if you place them every 2 feet.

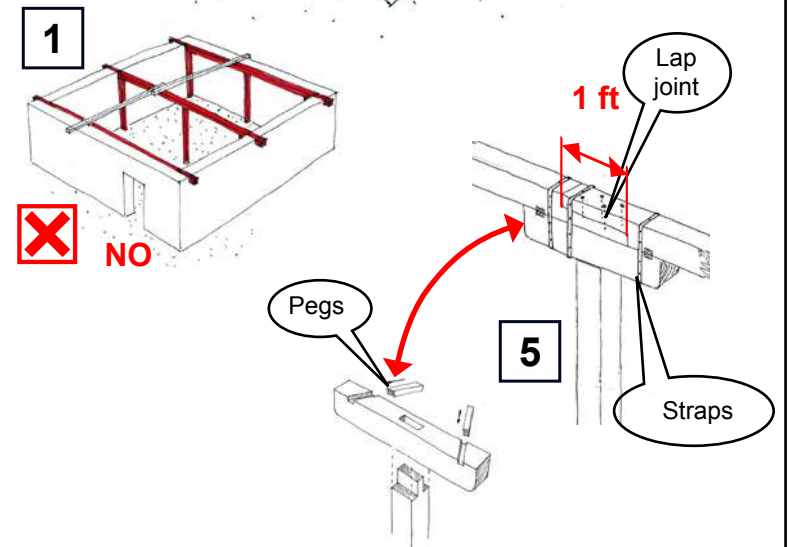
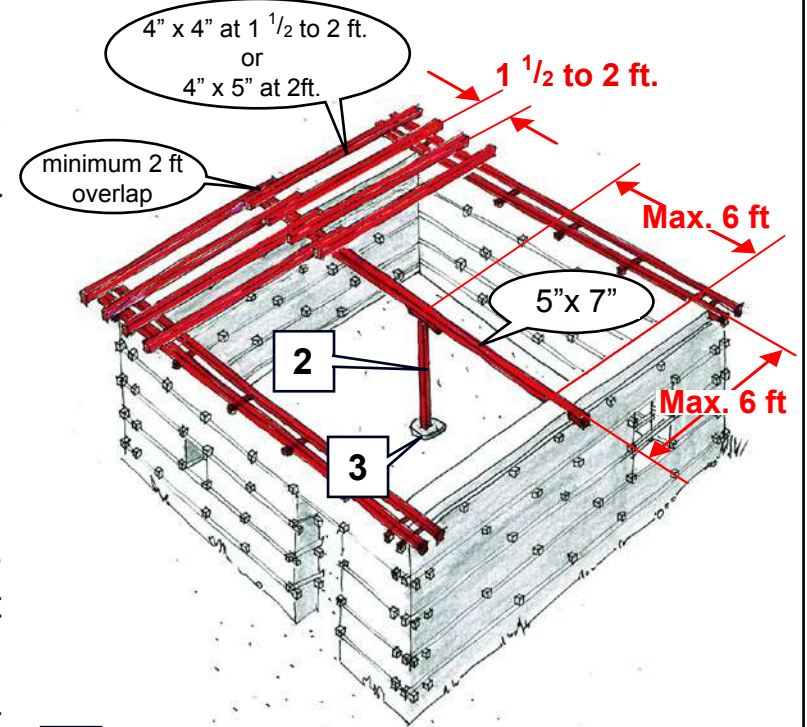

10. Adding a room

1. When you add a new room it must be connected to the existing room.
2. Don't make continuous vertical joints. It is dangerous. Your house will fall apart during an earthquake.
3. Open the corner where you want to add a room.
4. Connect the new beams with notches and nails.
5. Fill up tightly with stone, taking care to make them connect also into the new wall.

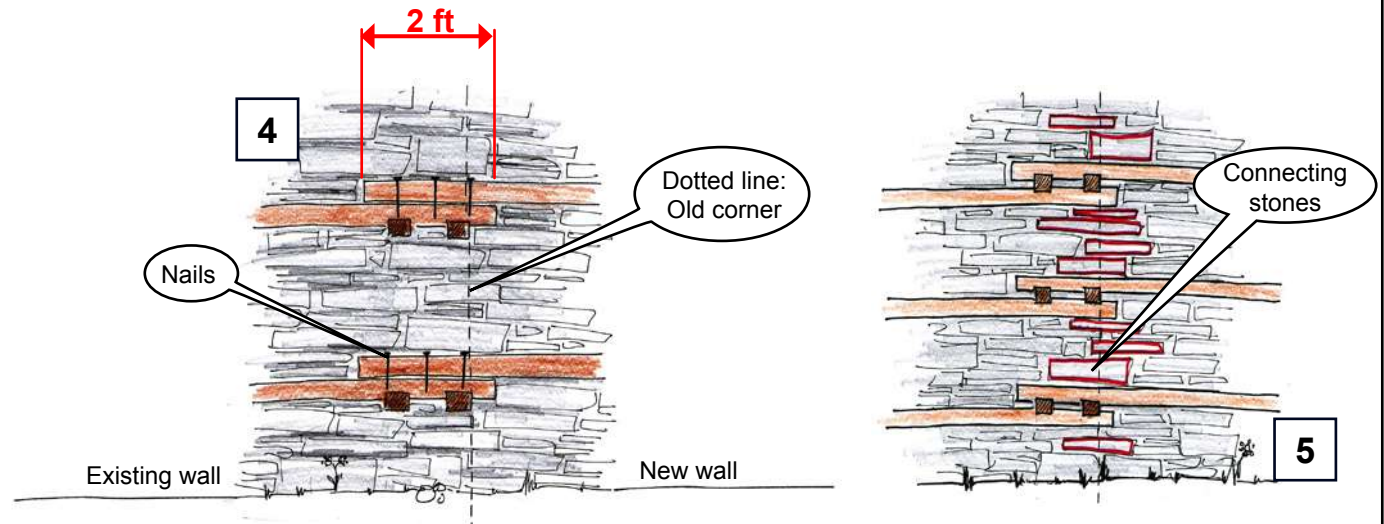
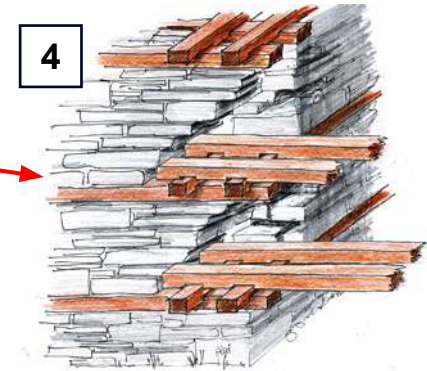
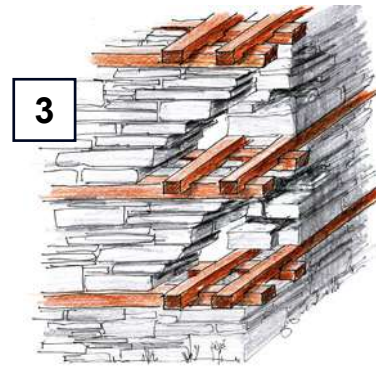
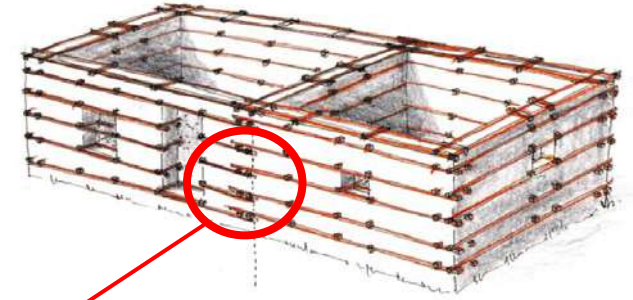
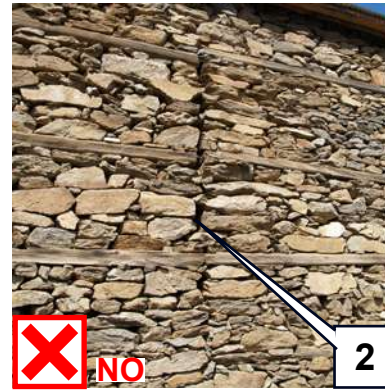

11. Think for your children



1

5 trees planted

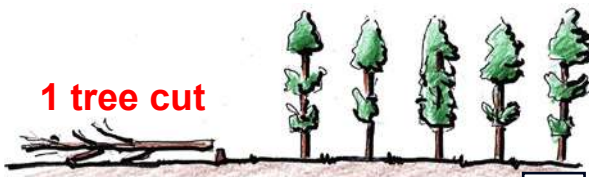

1 tree cut

2



1. Trees protect your land against landslides: the roots of the trees are like anchors in the ground.
2. Don't forget: For every tree you cut for your house, plant 5 new ones so that your children will also be able to build their house one day.

Guidebook prepared by:
-**Swiss Agency for Development and Cooperation** SDC

-**French Red Cross** FRC.
(Information Center, Batagram)

In collaboration with:
Belgian Red Cross
Architecture & Development
(technical research and development)

UN Habitat, NESPAK
(revisions)

Mansehra, NWFP, May 2007

